

# MBC04161 Bipolar Microstep Driver

## User's Guide



**ANAHEIM AUTOMATION**

910 East Orangefair Lane, Anaheim, CA 92801  
e-mail: [info@anaheimautomation.com](mailto:info@anaheimautomation.com)

(714) 992-6990 fax: (714) 992-0471  
website: [www.anaheimautomation.com](http://www.anaheimautomation.com)

## MBC04161 Microstep Driver Features

- Size (5.400"L x 1.868"W x 3.36"H)
- Output Current 4.0 Amps Peak
- 200 to 3200 steps/rev (1,2,5,10 and 16 selectable step operations)
- Short Circuit Protection
- Motor Cable Miss-Wire Detection
- No Minimum Inductance
- Optical Isolation
- Motor ON/OFF input

## Introduction

The MBC04161 Microstep Motor Driver has an output current capability of 1.0 Amps minimum to 4.0 Amps maximum (Peak Rating). The MBC04161 driver operates from a DC voltage of 24-48 Volts. The inputs are optically isolated with a minimum sourcing of 1.0mA per input (+5VDC minimum to +24VDC maximum). The clock input is set to receive either positive or negative edge clocks with a maximum frequency of 100kHz. The MBC04161 driver offers direction control and motor current ON/OFF capabilities. The Reduce Current Enabled automatically reduces motor current to 70% of set value after the last step is made (20msec delay). The driver has built-in features to indicate power on (Green LED) and clocks being received. (Yellow LED)

With the MBC04161, various step resolutions can be implemented by the onboard dip switch. These divisions range from 200 steps per revolution to 3200 steps per revolution. The bipolar drive configuration handles 4, 6, and 8 lead motors. Protection devices have been added to this driver for *Phase to Phase Short-Circuit and Motor Miss-Wire* conditions.

## Pin Descriptions

The inputs on the MBC04161 are optically isolated with the anode (+) and cathode (-) both brought out to the user. With no current going through the opto-diode the input is considered high. To enable the input a minimum of 1.0mA needs to be sourced or sunk through the opto-diode. This is done simply by placing a voltage of +5 to +24 VDC across the two inputs of the opto-diode. If sourcing current in to the inputs, then all three cathodes (-) should be tied together and grounded as shown in Figure 2. If sinking current, then all three anodes (+) should be tied together to the +voltage as shown in Figure 1. Provided on the MBC04161 is an external +5VDC out which can be used to power the inputs for sinking mode only. However if you use this voltage, isolation is not preserved.

## TB2: 5 Pin Terminal Description

Pin #	Description
1	Phase A: Phase 1 of the step motor
2	Phase $\bar{A}$ : Phase 3 of the step motor
3	Phase B: Phase 2 of the step motor
4	Phase $\bar{B}$ : Phase 4 of the step motor
5	Motor Ground

Table 1: TB2 Terminal Descriptions

## TB1: 8 Pin Terminal Description

Pin #	Description
1	Step Clock Input Anode (+): A positive going edge on this isolated input advances the motor one increment. The size of the increment is dependent on the Microstep Select Inputs of Switch 1.
2	Step Clock Input Cathode (-)
3	Direction Anode (+): This isolated input is used to change the direction of the motor. Physical direction also depends on the connection of the motor windings.
4	Direction Cathode (-)
5	ON/OFF Anode (+): This isolated input is used to enable and disable the output section of the driver. When HIGH (open) the outputs are enabled. However, this input does not inhibit the step clock.
6	ON/OFF Cathode (-)
7	+5 VDC: This non-isolated output can be used to supply up to 50mA of current to the isolated inputs. By doing this, isolation will be disabled.
8	0 VDC: +5 VDC return.

Table 2: TB1 Terminal Descriptions

## TB3: 3 Pin Terminal Description

Pin #	Description
1	VIN (+24 to +48VDC)
2	0VDC
3	Earth Ground

Table 3: TB3 Terminal Descriptions

## Optically Isolated Inputs

The following inputs to the MBC04161 are Optically Isolated.

Item	Pin #
Clock	1 & 2
Direction	3 & 4
On/Off	5 & 6

Table 4: Inputs That are Optically Isolated

To enable an input, apply a DC voltage source of +5VDC to +24VDC across the inputs. The Anodes (+) are pins 1,3,and 5 and the Cathodes (-) are pins 2, 4, and 6.

## Absolute Maximum Ratings

Input Voltage: 55 VDC

Output Current: 4.0 AMPS PEAK

Max Plate Temperature: 70° C

Storage Temperature: 0° to +50° C

Input Voltage (For isolated inputs): +5V to +24V

## Electrical Specifications

Item	Min	Typ	Max	Units
Input Voltage	20	48	55	VDC
Phase Output Current	0.7		2.8	A (RMS)
Phase Output Current	1.0		4.0	A (PEAK)
Clock Frequency	0		100	kHz
Chopping Frequency	20	27	33	kHz
+5VDC Out	4.8	5	5.2	V
+5VDC Out	0		50	mA
Operation Temperature	0		70	C

Table 5: Specifications

## Hook Up Drawings

### Sinking:

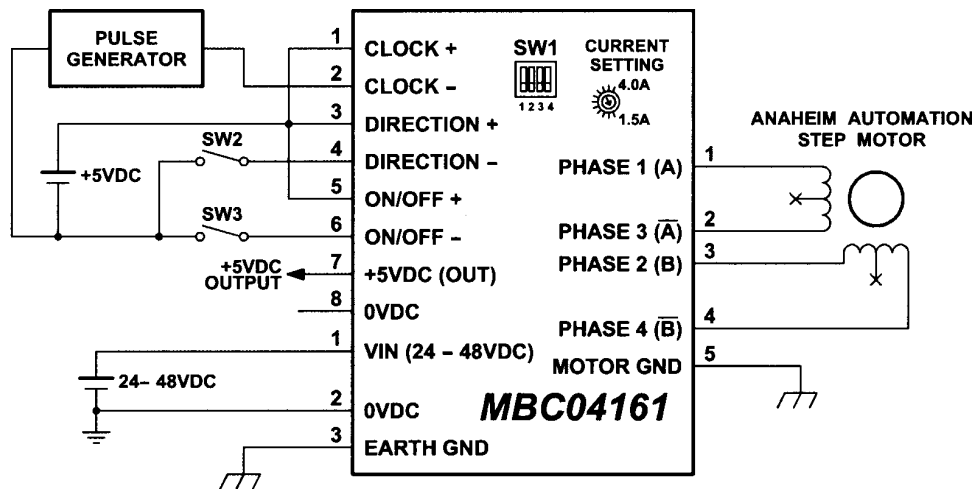

Figure 1: Hook Up for Sinking Current

### Sourcing:

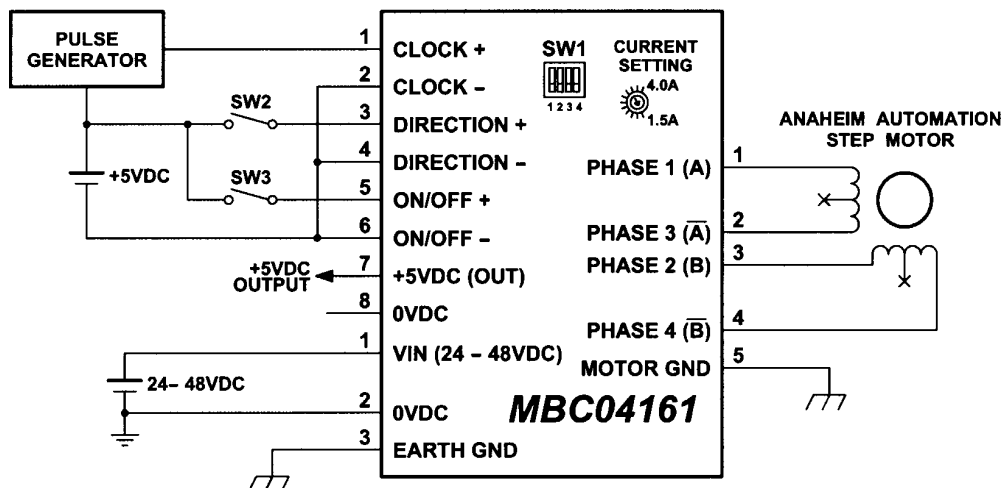

Figure 2: Hook Up for Sourcing Current

## Dimension Drawing

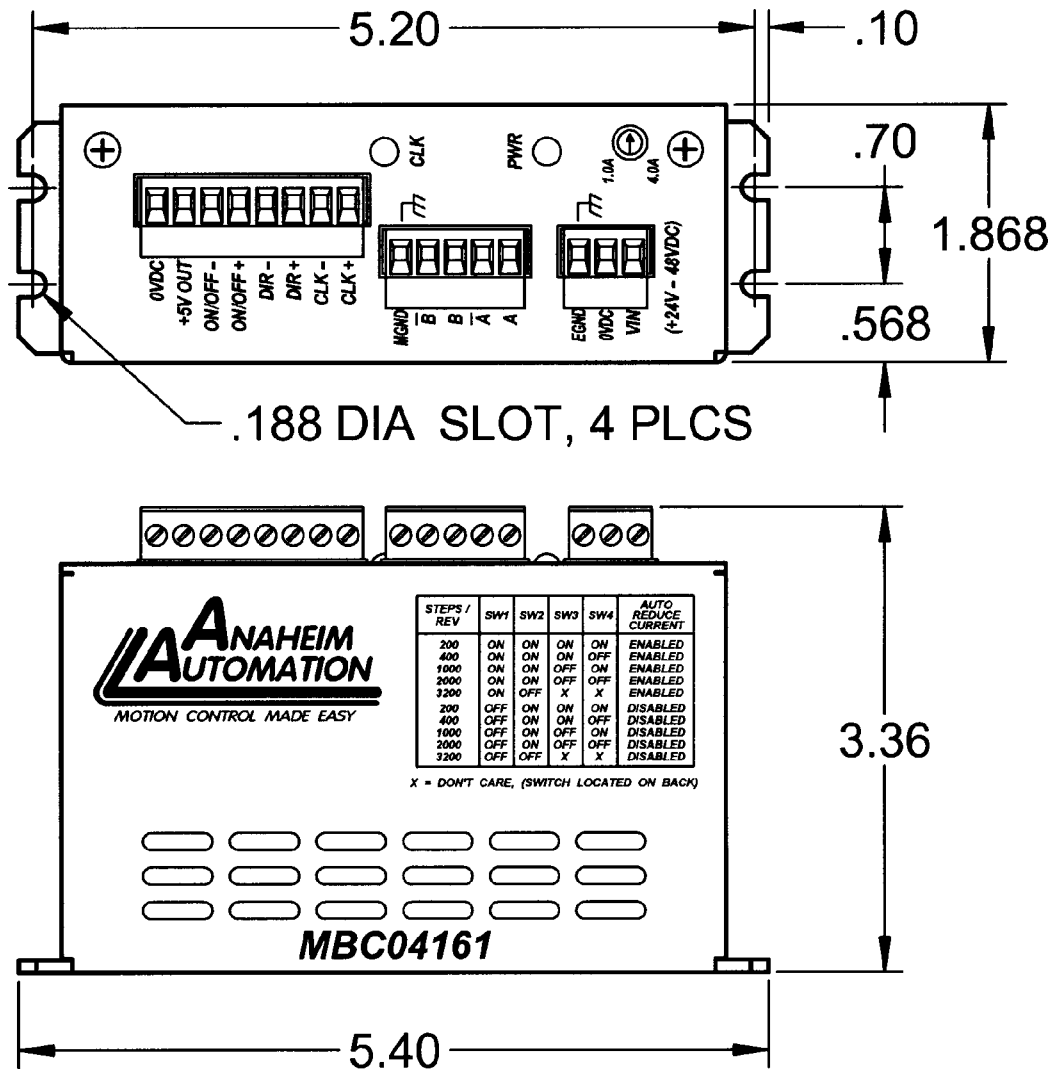

Figure 3: Dimension Drawing for the MBC04161

## Motor Selection

The MBC04161 is a Bipolar Microstep Driver that is compatible with both Bipolar and Unipolar Motor Configurations, (i.e. 8 and 4 lead motors, and 6 lead center tapped motors).

*Step motors with low current ratings and high inductance will perform better at low speeds, providing higher low-end torque. Motors with high current ratings and low inductance will perform better at higher speeds, providing more high-end torque.*

Since the MBC04161 is a constant current source, it is not necessary to use a motor that is rated at the same voltage as the supply voltage. What is important is that the MBC04161 is set to the appropriate current level based on the motor being used. Higher voltages will cause the current to flow faster through the motor coils. This in turn means higher step rates can be achieved. *Care should be taken not to exceed the maximum voltage of the driver.*

**Anaheim Automation offers a comprehensive line of step motors in 17, 23, 34 and 42 frame sizes. Contact the factory to verify motor/ drive compatibility.**

## Step Motor Selection Guide

Part Number	Unipolar Rating	Series Peak Rating	Parallel Peak Rating	Series Current Setting	Parallel Current Setting
23L206	3.0A	3.0A	6.0A	70%	100%
23L306	3.0A	3.0A	6.0A	70%	100%
34N108	4.0A	4.0A	8.0A	100%	100%
34N207	3.5A	3.5A	7.0A	85%	100%
34N307	3.5A	3.5A	7.0A	85%	100%
23L108	4.0A	4.0A	8.0A	100%	100%
23L106	3.0A	3.0A	6.0A	70%	100%
23L104	2.0A	2.0A	4.0A	35%	100%
17L203	1.5A	1.5A	3.0A	20%	70%
17L202	1.0A	1.0A	2.0A	0%	35%
17L002	1.0A	1.0A	2.0A	0%	35%

Table 6: Step Motor Selection Guide

**Anaheim Automation offers motor cable, making hook-ups quick and easy!  
Contact the factory or visit our website for more motor and cable offerings.**

## Microstep Selection (SW1 Settings)

Switches 2, 3 and 4, of the DIP switch select the number of microsteps per step. The table below shows the standard resolution values along with the associated positions for the select switches. The standard waveforms are sinusoidal.

Resolution	Steps/Rev	Select 1	Select 2	Select 3	Select 4	Auto Reduce Current
1	200	OFF	ON	ON	ON	Disabled
2	400	OFF	ON	ON	OFF	Disabled
5	1000	OFF	ON	OFF	ON	Disabled
10	2000	OFF	ON	OFF	OFF	Disabled
16	3200	OFF	OFF	OFF	OFF	Disabled
1	200	ON	ON	ON	ON	Enabled
2	400	ON	ON	ON	OFF	Enabled
5	1000	ON	ON	OFF	ON	Enabled
10	2000	ON	ON	OFF	OFF	Enabled
16	3200	ON	OFF	OFF	OFF	Enabled

Table 7: SW1 Switch Settings

## Setting the Output Current

The output current on the MBC04161 is set by an onboard potentiometer. This potentiometer determines the per phase peak output current of the driver. The relationship between the output current and the potentiometer value is as follows:

Peak Current	Potentiometer Setting	Peak Current	Potentiometer Setting
1.0A	0%	2.8A	60%
1.3A	10%	3.1A	70%
1.6A	20%	3.4A	80%
1.9A	30%	3.7A	90%
2.2A	40%	4.0A	100%
2.5A	50%	--	--

Table 8: Output Current POT Settings  
*Refer to Table 6 for specific motor current settings.*

## Reducing Output Current

Reducing the output current is accomplished by setting switch 1 of the DIP switch to the ON position and occurs approximately 20mSec after the last positive going edge of the step clock input. The amount of current per phase in the reduction mode is approximately 70% of the set current. When the current reduction circuit is activated, the current reduction resistor is paralleled with the current adjustment potentiometer. This lowers the total resistance value, and thus lowers the per phase output current.

## Determining Output Current

The output current for the motor used when microstepping is determined differently from that of a full/half step unipolar driver. In the MBC04161, a sine/cosine output function is used in rotating the motor. The output current for a given motor is determined by the motors current rating and the wiring configuration of the motor. There is a current adjustment potentiometer used to set the output current of the MBC04161. This sets the peak output current of the sine/cosine waves. The specified motor current (which is the unipolar value) is multiplied by a factor of 1.0, 1.4, or 2.0 depending on the motor configuration (series, half-coil, or parallel).

## Step Motor Configurations

Step motors can be configured as 4, 6, or 8 leads. Each configuration requires different currents. Refer to the lead configurations and the procedures to determine their output current.

**WARNING!** Step motors will run hot even when configured correctly. Damage may occur to the motor if a higher than specified current is used. Most specified motor currents are maximum values. Care should be taken to not exceed these ratings.

## 6 Lead Motors

When configuring a 6 lead motor in a **half-coil configuration** (connected from one end of the coil to the center tap), multiply the specified per Phase (or unipolar) current rating by 1.4 to determine the current setting potentiometer value. This configuration will provide more torque at higher speeds when compared to the series configuration.

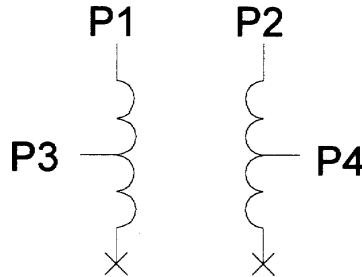

Figure 4: Half Coil Motor Connection

When configuring the motor in a **series configuration** (connected from end to end with the center tap floating) use the specified per Phase (or unipolar) current rating to determine the current setting potentiometer value.

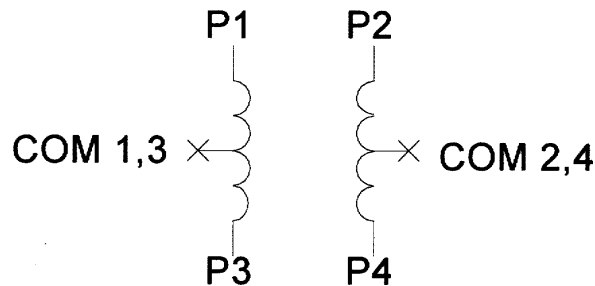

Figure 5: Series Motor Connection

## 4 Lead Motors

Multiply the specified **series** motor current by 1.4 to determine the current adjustment potentiometer value. Four Lead Motors are usually rated with their appropriate series current, as opposed to the *Phase Current*, which is the rating for 6 and 8 lead motors.

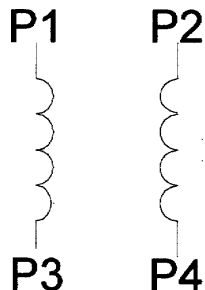

Figure 6: Series Motor Connection



## 8 Lead Motors

**Series Connection:** When configuring the motor windings in series, use the per Phase (or unipolar) current rating to determine the current setting potentiometer value.

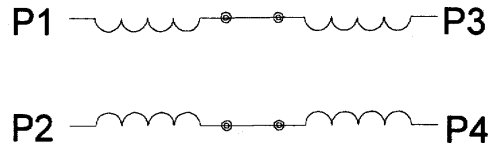

Figure 7: Series Motor Connection

**Parallel Connection:** When configuring the motor windings in parallel, multiply the per Phase (or unipolar) current rating by 2.0 to determine the current setting potentiometer value.

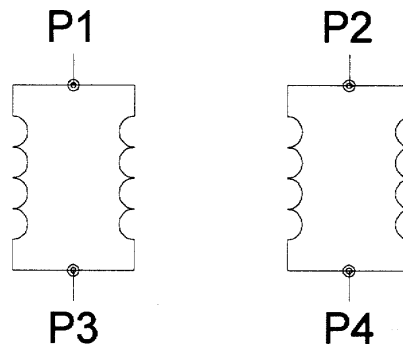

Figure 8: Parallel Motor Connection

**NOTE:** After the current has been determined, according to the motor connections above, use Table 8 to choose the proper setting for the current setting potentiometer.

### Connecting the Step Motor

Phase 1 and Phase 3 of the step motor are connected to pins 1 and 2 on connector TB2. Phase 2 and Phase 4 of the step motor are connected to pins 3 and 4 on connector TB2. The motors case can be grounded to pin 5 on connector TB2. Refer to Figures 1 & 2 for TYPICAL APPLICATION HOOK-UP.

**NOTE:** The physical direction of the motor with respect to the direction input will depend on the connection of the motor windings. To reverse the direction of the motor with respect to the direction input, switch the wires on Phase 1 and Phase 3.

**WARNING:** Do not connect or disconnect motor wires while power is applied!

### Miss-Wire Detection

When power is applied to the MBC04161 there is a brief moment for miss-wire checks of the motor cables. If it is found that there is a miss-wire, the yellow LED will blink and power will be shut off to the motor. To reset the drive turn power off, check wiring, and turn power back on.

# Torque Speed Curves

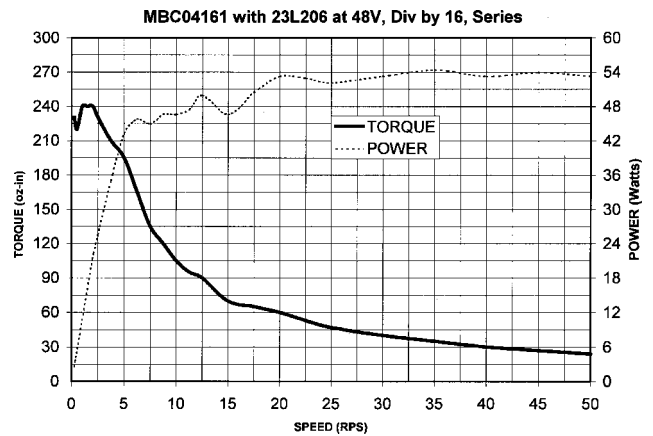
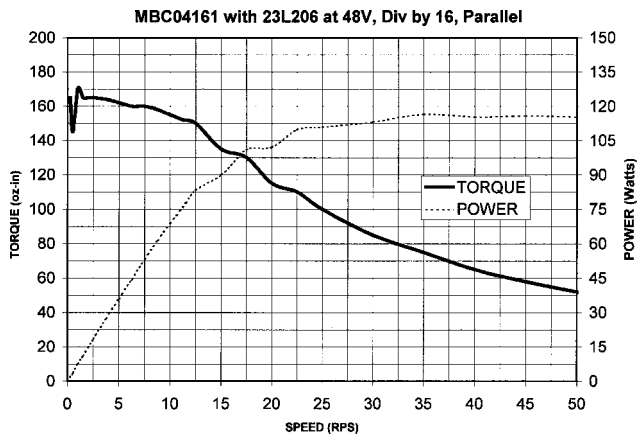
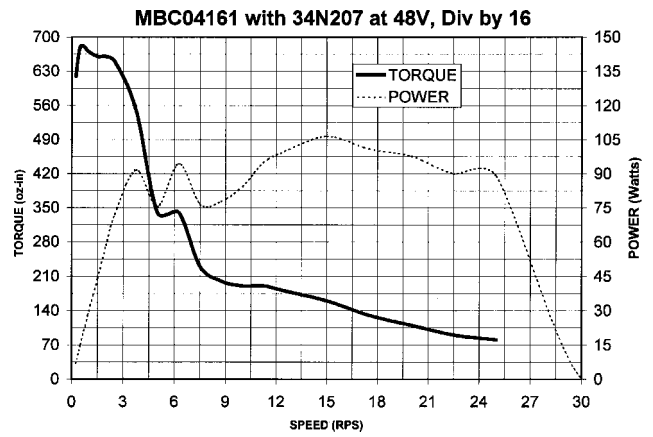
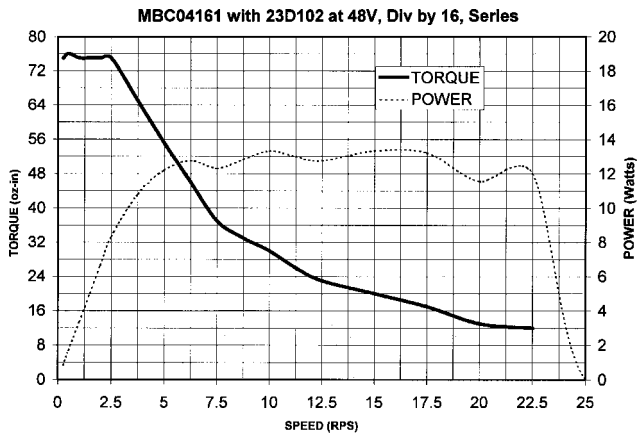
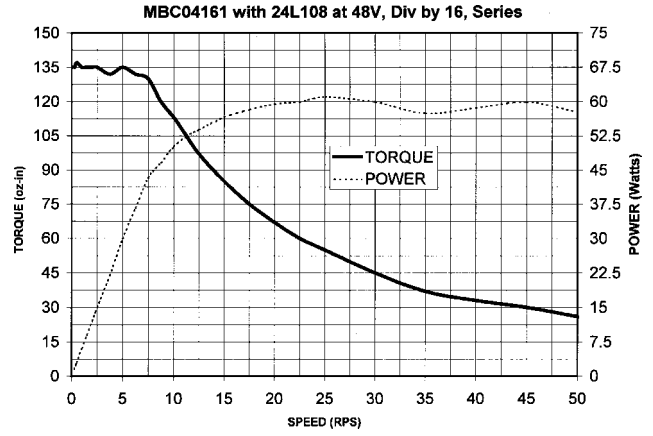
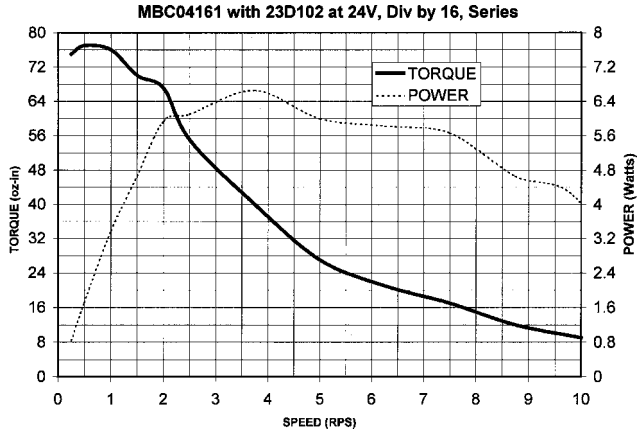

## **COPYRIGHT**

Copyright 2001 by Anaheim Automation. All rights reserved. No part of this publication may be reproduced, transmitted, transcribed, stored in a retrieval system, or translated into any language, in any form or by any means, electronic, mechanical, magnetic, optical, chemical, manual, or otherwise, without the prior written permission of Anaheim Automation, 910 E. Orangefair Lane, Anaheim, CA 92801.

## **DISCLAIMER**

Though every effort has been made to supply complete and accurate information in this manual, the contents are subject to change without notice or obligation to inform the buyer. **In no event will Anaheim Automation be liable for direct, indirect, special, incidental, or consequential damages arising out of the use or inability to use the product or documentation.**

Anaheim Automation's general policy does not recommend the use of its' products in life support applications wherein a failure or malfunction of the product may directly threaten life or injury. Per Anaheim Automation's Terms and Conditions, the user of Anaheim Automation products in life support applications assumes all risks of such use and indemnifies Anaheim Automation against all damages.

## **LIMITED WARRANTY**

All Anaheim Automation products are warranted against defects in workmanship, materials and construction, when used under Normal Operating Conditions and when used in accordance with specifications. This warranty shall be in effect for a period of twelve months from the date of purchase or eighteen months from the date of manufacture, whichever comes first. **Warranty provisions may be voided if products are subjected to physical modifications, damage, abuse, or misuse.**

Anaheim Automation will repair or replace at its' option, any product which has been found to be defective and is within the warranty period, provided that the item is shipped freight prepaid, with previous authorization (RMA#) to Anaheim Automation's plant in Anaheim, California.

## **TECHNICAL SUPPORT**

If you should require technical support or if you have problems using any of the equipment covered by this manual, please read the manual completely to see if it will answer the questions you have. Be sure to refer to the TROUBLESHOOTING section of this manual. If you need assistance beyond what this manual can provide, contact your Local Distributor where you purchased the unit, or contact the factory direct.

# *ANAHEIM AUTOMATION*